

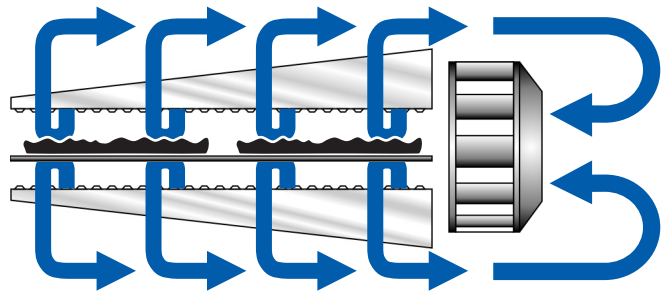

### Principle

Middleby Marshall PS Series conveyor ovens bake both faster and at a lower temperature than other ovens. Pantened vertical columns of hot air move heat aerodynamically instead of using high temperatures. The streams of hot air remove the boundary layers of cool heavy air which tend to insulate the product. All Middleby ovens are designed to cook a multitude of products including pizza, seafood, sandwiches, bagels, ethnic foods and more.



### Standard Features

- **Impingement PLUS!** low oven profile and dual air return
- **Patented EMS energy Management System** reduces gas consumption and increases cooking efficiency
- 55" (1397mm) long cooking chamber
- 32" (813mm) wide, 90" (2286mm) long conveyor belt
- Stackable up to four units high
- Patented "Jet Sweep" impingement process that delivers constant heat to the chamber.
- Microprocessor-controlled bake time/conveyor speed
- Customer-specific adjustable jet fingers that allow control of heating delivery
- Stainless steel front, sides and top
- Front-loading window with cool handle
- Reversible conveyor direction

### Optional Features

- Split belt - two 15" (381mm) belts with individually adjustable speed settings

### Conserves Energy

Middleby ovens provide very efficient heat transfer to product. Energy is conserved as air is recycled from heater to product, with minimum flue or vent loss.

### Cleanability

PS555 Ovens are designed for easy cleaning. Removable parts include: crumb pans, end panels, air fingers, and a folding conveyor belt assembly.

### Easily Services

Control compartment is designed for quick and easy access. Primary electrical components are door-mounted.

### Warranty

All PS555 models have a one year parts and labor warranty. Oven start-up and demonstration are included at no additional charge (USA Only)

### Ventilation

For installation under a ventilation hood only.

\*Patent Pending



PS555G Rev 5 4/18



1401 Toastmaster Drive  
Elgin, IL 60120 USA  
(847) 741-3300 Fax: (847) 741-0015  
www.middleby.com

**TOP VIEW**

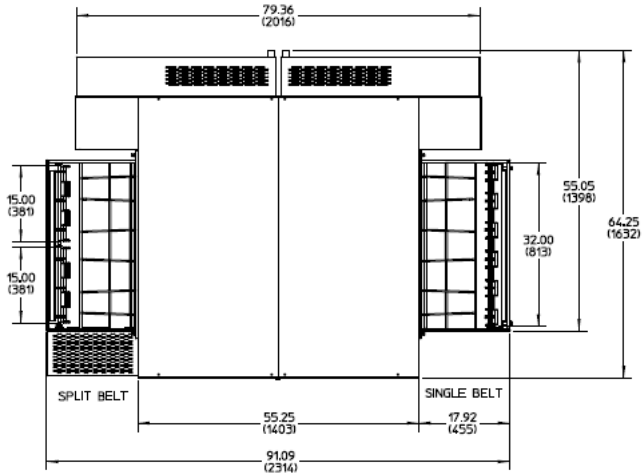

**SIDE VIEW**

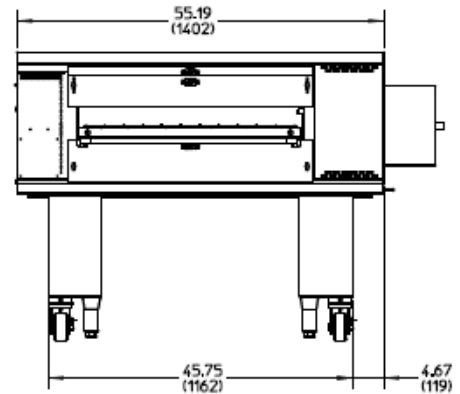

**PS555-1 Single Oven**

**FRONT VIEW**

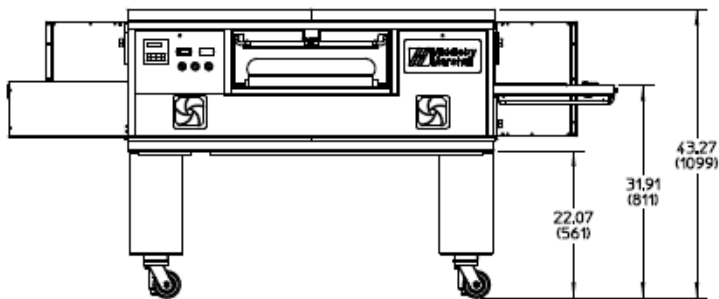

**BACK VIEW**

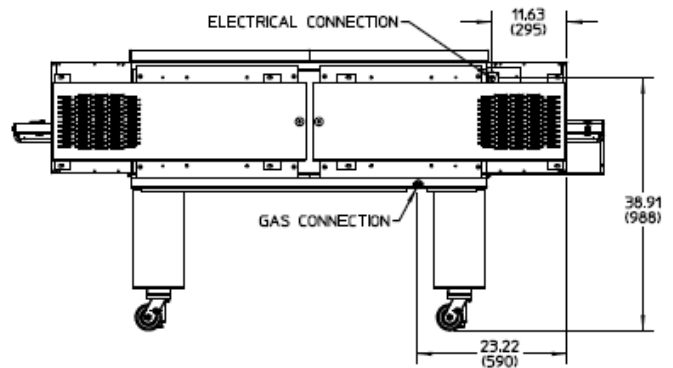

**PS555-2 Double Oven**

**FRONT VIEW**

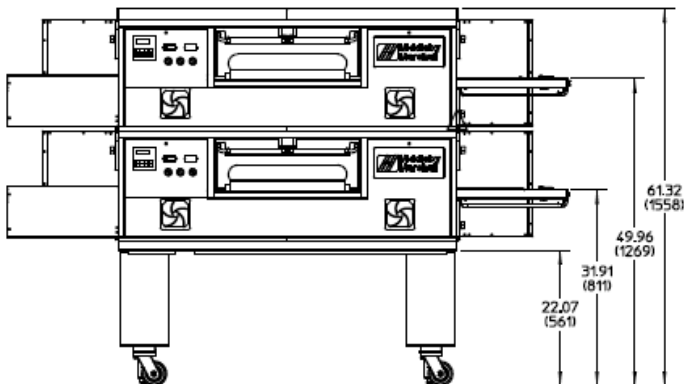

**BACK VIEW**

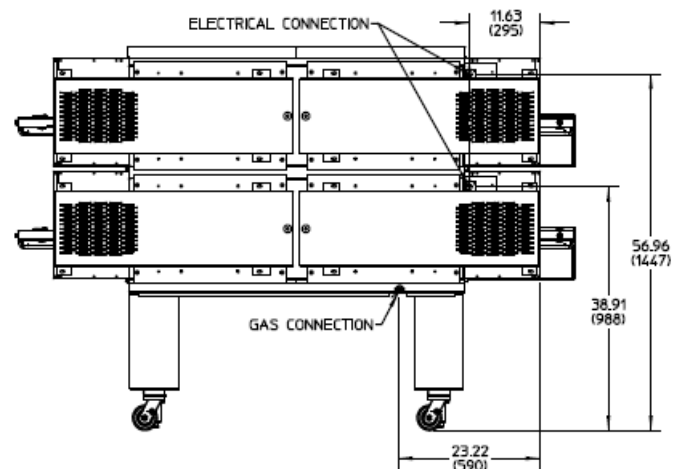

**PS555-3 Triple Oven without legs**

**FRONT VIEW**

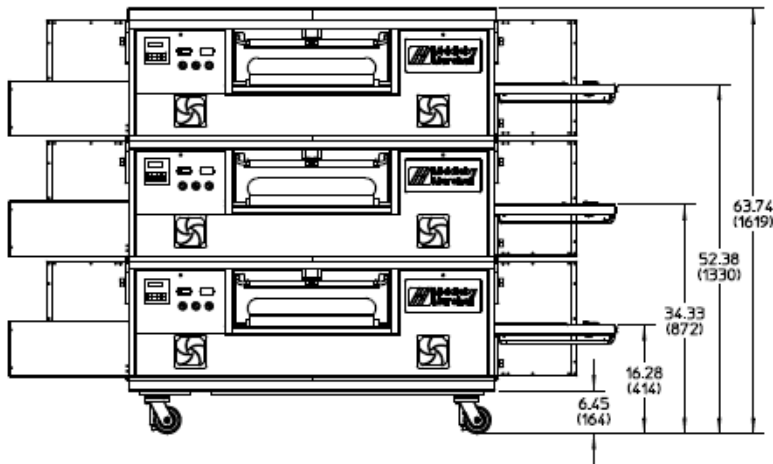

**BACK VIEW**

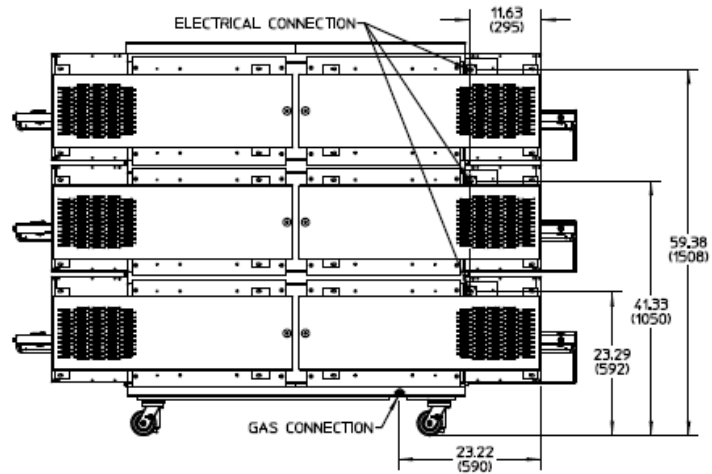

**PS555-4 Quad Oven with outriggers**

**FRONT VIEW**

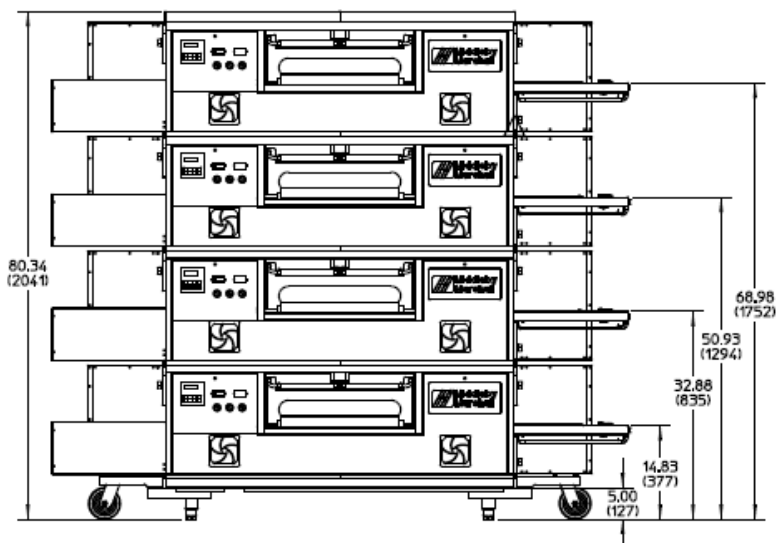

**BACK VIEW**

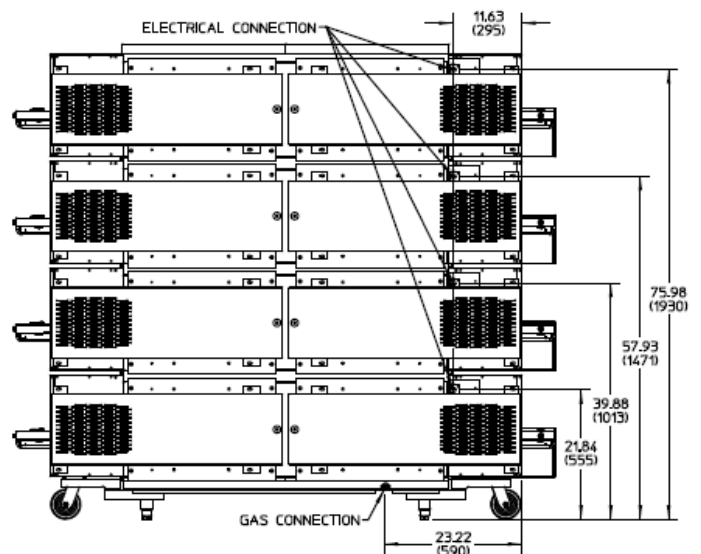



**RECOMMENDED MINIMUM CLEARANCES**

Rear of Oven to Wall	Control end of conveyor to wall	Non-control end of conveyor to wall
6" (152mm)	0" (0mm)	0" (0mm)

**GENERAL SPECIFICATIONS**







	Heating Zone	Baking Area	Belt Length	Belt Width	Depth	Height	Max. Temp	Bake Time Range	Ship Wt	Ship Cube
PS555-1	55" 1397mm	12.2sq.ft. 1.13m <sup>2</sup>	91" 2311mm	1 x 32" (813mm) or 2 x 15" (381mm)	64-1/4" 1632mm	43-1/2" 1099mm	550°F 288°C	2:40- 29:50	1250lbs. 568kg	160ft <sup>3</sup> 4.5m <sup>3</sup>
PS555-2	110" 2794mm	24.4sq.ft. 2.27m <sup>2</sup>	91" 2311mm	1 x 32" (813mm) or 2 x 15" (381mm)	64-1/4" 1632mm	61-1/3" 1558mm	550°F 288°C	2:40- 29:50	2500lbs. 1135kg	320ft <sup>3</sup> 9.0m <sup>3</sup>
PS555-3	165" 4191mm	36.6sq.ft. 3.40m <sup>2</sup>	91" 2311mm	1 x 32" (813mm) or 2 x 15" (381mm)	64-1/4" 1632mm	63-3/4" 1619mm	550°F 288°C	2:40- 29:50	3750lbs. 1703kg	480ft <sup>3</sup> 13.5m <sup>3</sup>
PS555-4 with outriggers	220" 5588mm	48.8sq.ft. 4.54m <sup>2</sup>	91" 2311mm	1 x 32" (813mm) or 2 x 15" (381mm)	64-1/4" 1632mm	80-1/3" 2041mm	550°F 288°C	2:40- 29:50	5000lbs. 2270kg	640ft <sup>3</sup> 18.0m <sup>3</sup>

**ELECTRICAL SPECIFICATIONS**

Model	Version	Voltage	Phase	Freq	Amps*	Supply	Breakers
PS555		208v	1	60 Hz	12A	2 pole, 3 wire (2 hot, 1 ground)	As per local codes
PS555		220-240v	1	50 Hz	10A	2 pole, 3 wire (2 hot, 1 ground)	As per local codes

\* The current draw rating shown above are maximum values for normal operation, amperage draw will be less than the listed value.  
NOTE: Each oven includes a 6 ft cord with NEMA# L6-20P plug. Customer to provide NEMA# L6-20R receptacle

**GAS SUPPLY SPECIFICATIONS**

Version	Gas Type	North America II <sub>2ELL3B/P</sub>	IE,IT,PT,ES,GB II <sub>2ELL3B/P</sub>	DE II <sub>2ELL3B/P</sub>	NL II <sub>2L3B/P</sub>	BE, FR II <sub>2E+3+</sub>	AT,CH,DK,FI,SE II <sub>2H3B/P</sub>	Rated Heat Input
	Natural Gas	6-12" W.C. (14.9-29.9mbar)	-	-	-	-	-	150,000BTU (44kW-hr)
	Propane Gas	11-14" W.C. (27.4-34.9mbar)	-	-	-	-	-	150,000BTU (44kW-hr)
	G20	-	20mbar	20mbar	-	20-25mbar	20mbar	44kW-hr
	G25	-	-	20mbar	25mbar	-	-	44kW-hrr
	G20, G25	-	20mbar	20mbar	25mbar	20-25mbar	20mbar	44kW-hrr
	G30	-	29-37mbar	-	28-30mbar	29-37mbar	50mbar	44kW-hr
	G30, G31	-	-	50mbar	30mbar	-	50mbar	44kW-hr

The required gas supply pressures of other locations are dependent on the local gas type and on all applicable local codes. **Minimum**

**Gas Pipe Sizes:**

- \* Natural Gas - 2" (50.8 mm) main supply line. One 1-1/4" (12.7mm) NPT branch per oven cavity with individual full-flow shutoff valve.
- \* Propane Gas - 2" (50.8 mm) main supply line. One 1-1/4" (12.7mm) NPT branch per oven cavity with individual full-flow shutoff valve

**ALL SPECIFICATIONS SUBJECT TO CHANGE WITHOUT NOTICE.**